

Spare parts / Accessories

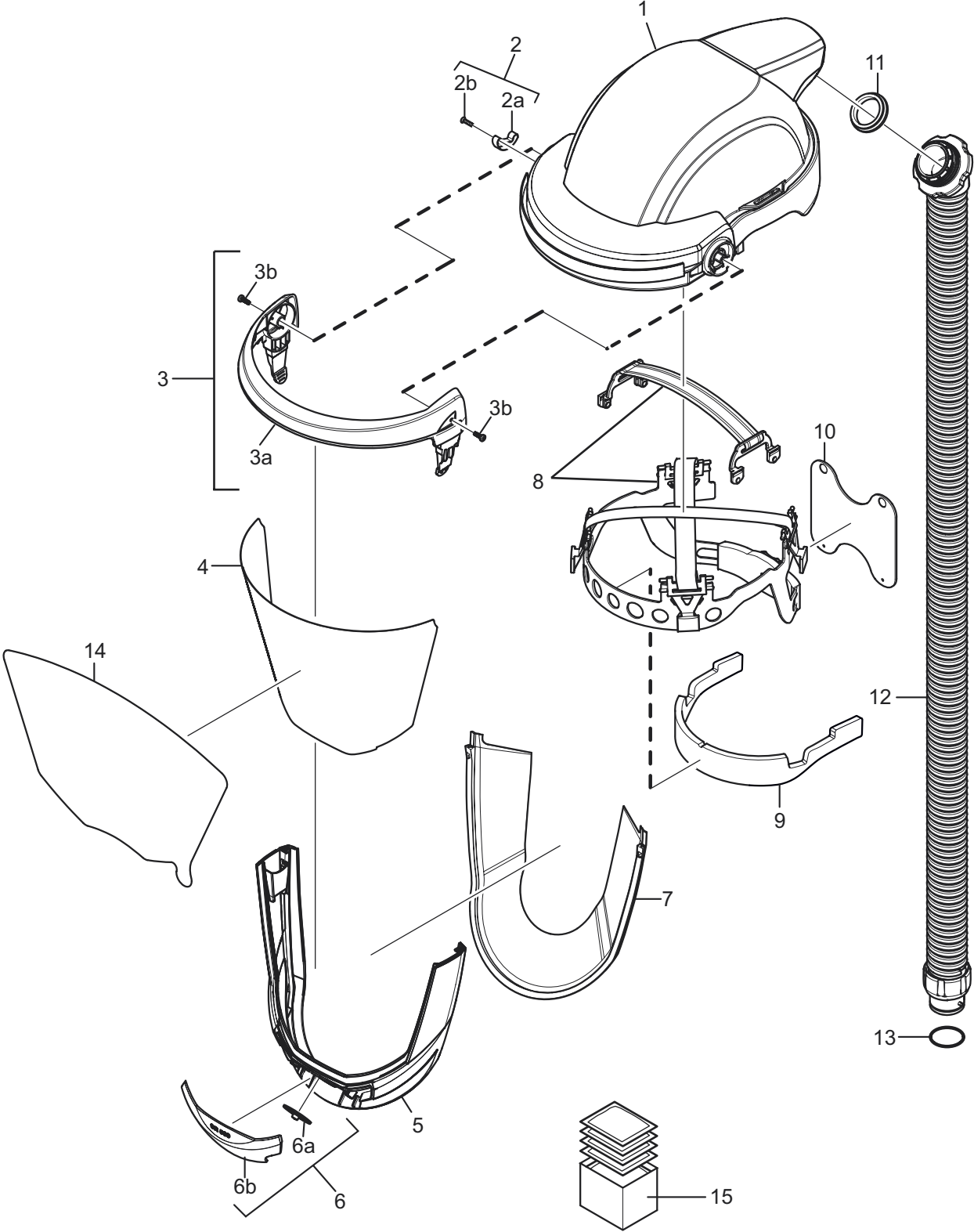

No.	Description	Ordering No.
1.	Helmet, incl. air duct	R06-0830
2.	Leaf spring with screw	R06-0806
2a.	Leaf spring	-
2b.	Screw	-
3.	Upper frame set	R06-0802
3a.	Upper frame	-
3b.	Screw	-
4.	Visor, PC	R06-0808
5.	Lower frame set	R06-0803
6.	Set of valves	R06-0807
6a.	Membrane	-
6b.	Cover exhalation valve	-
7.	Face seal	R06-0805
8.	Head harness	R06-0804
9.	Sweatband	R06-0809
10.	Neck comfort band	T06-0803
11.	Gasket	R01-1205
12.	Breathing hose	R06-0810
13.	O-ring	R06-0202
14.	Peel of set SR 582	T06-0801
15.	Cleaning wipes. 50/box	H09-0401